



Thermal Image Scope PANTHER 2.0 Series

User Manual V5.5.64 202304



Contact Us

Table of Contents

Chapter 1 Overview	1
1.1 Device Description	1
1.2 Main Function	1
1.3 Appearance	1
Chapter 2 Preparation	4
2.1 Cable Connection	4
2.2 Install Battery	4
2.2.1 Battery Instruction	4
2.2.2 Battery Installation	4
2.3 Install Rail	6
2.4 Power On/Off	6
2.5 Menu Description	7
2.5.1 Main Menu	7
2.5.2 Quick Menu	8
2.6 Client Software Connection	8
2.7 Firmware Status	9
2.7.1 Check Firmware Status	9
2.7.2 Upgrade Device	10
2.8 Zeroing	11
Chapter 3 Image Settings	12
3.1 Adjust Diopter	12
3.2 Adjust Focus	12
3.3 Adjust Image Brightness	13
3.4 Adjust Contrast	13
3.5 Adjust Tone	13
3.6 Adjust Sharpness	13
3.7 Select Scene Mode	14
3.8 Set Palettes	14
3.9 Correct Defective Pixel	16
3.10 Flat Field Correction	17

Thermal Image Scope User Manual

3.11 Set Picture in Picture Mode	17
3.12 Set Zoom Mode.....	17
Chapter 4 Zeroing	19
4.1 Select Zeroing Profile	19
4.2 Correct Reticle	19
4.3 Set Reticle Style	21
Chapter 5 Measure Distance	22
Chapter 6 General Settings.....	23
6.1 Set OSD	23
6.2 Set Brand Logo	23
6.3 Adjust Display Brightness	23
6.4 Burning Prevention	24
6.5 Capture and Video	24
6.5.1 Capture Picture	24
6.5.2 Record Video	24
6.5.3 Set Audio.....	25
6.5.4 Prerecord Video	25
6.6 Hot Tracking.....	25
6.7 Export Files	26
6.7.1 Export Files via HIKMICRO Sight.....	26
6.7.2 Export Files via PC	27
Chapter 7 System Settings.....	29
7.1 Adjust Date	29
7.2 Adjust Time.....	29
7.3 Set Unit	29
7.4 Set Language.....	29
7.5 View Device Information	30
7.6 Restore Device	30
Chapter 8 Frequently Asked Questions	31
8.1 Why is the monitor off?	31
8.2 The image is not clear, how to adjust it?	31

Thermal Image Scope User Manual

8.3 Capturing or recording fails. What's the problem?	31
8.4 Why the PC cannot identify the device?	31
Chapter 9 Appendix.....	32
9.1 Device Command	32
9.2 Device Communication Matrix	32
Safety Instruction	33
Legal Information	36
Regulatory Information	38

Chapter 1 Overview

1.1 Device Description

HIKMICRO PANTHER 2.0 Thermal Image Scope provides clear image under harsh environment conditions like darkness, fog, smoke, dust, rain, snow, etc. The scope is mainly applied to scenarios such as hunting.

1.2 Main Function

Distance Measurement

The device can detect the distance between the target and the observation position.

Hot Tracking

The device can detect the highest temperature in the scene and mark the spot. This function varies according to different camera models.

Zeroing

The reticle helps you to aim at the target fast and accurately. See **Zeroing**.

Image Correction

The device supports DPC (Defective Pixel Correction) and FFC (Flat Field Correction) which can optimize the image quality.

Large Digital Zoom

Digital zoom up to 8× offers better focus on small target from a far distance.

Audio & Recoil-activated Recording

The device can record audio and support recoil-activated recording.

Brightness & Tone Adjustment

You can adjust the brightness and tones as needed.

Client Software Connection

The device can capture snapshots, record videos, export files, set parameters, and upgrade firmware by HIKMICRO Sight after being connected to your phone via hotspot.

1.3 Appearance

There are two types of thermal image scopes. The appearance description of the two types are shown below. Please take the actual product for reference.

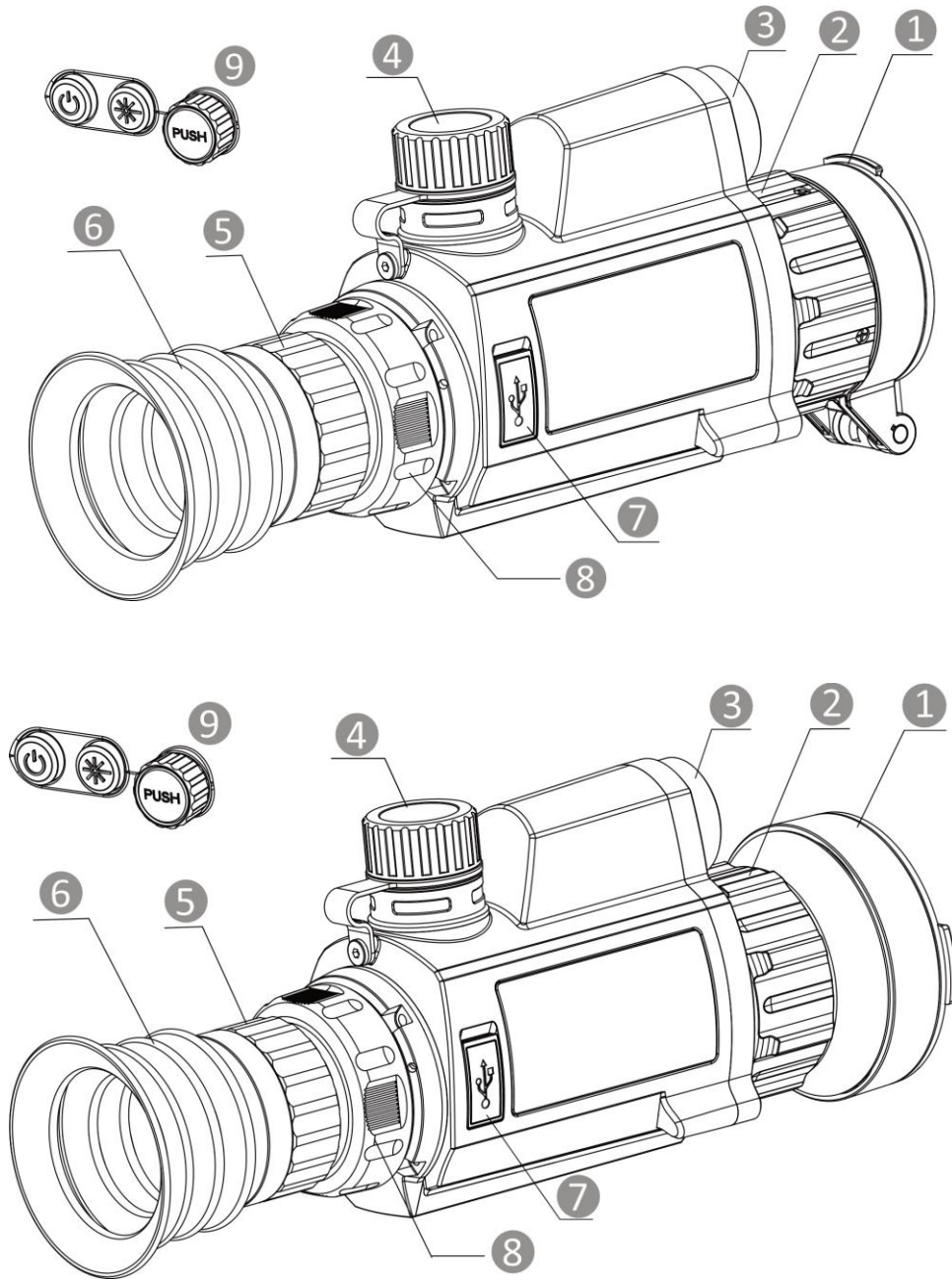

Figure 1-1 Appearance



Table 1-1 Components

No.	Description	Function
1	Lens Cover	Protects the lens.
2	Focus Ring	Adjusts focus to obtain clear targets.
3	Laser Range	Measures the distance with laser.

Thermal Image Scope User Manual

No.	Description	Function
	Finder	
4	Battery Compartment	For holding the battery.
5	Diopter Adjustment Ring	Adjusts the dioptic setting.
6	Eyepiece	The piece placed closest to the eye to view the target.
7	Type-C Interface	To connect the device to power supply or to transmit data with a type-C cable.
8	Fixing Ring	To fix the eyepiece.
9	Buttons	To set functions and parameters.

Table 1-2 Button Description

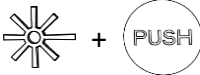
No.	Description	Function
	Power Key	<ul style="list-style-type: none"> ● Press: Standby mode/Wake up device ● Hold: Power on/off
	Measure Key	<ul style="list-style-type: none"> ● Press once: Turn on laser ranging/Measure distance with laser ● Press twice: Turn off laser ranging ● Hold: Capture snapshots
	Wheel	<ul style="list-style-type: none"> ● Press: Call quick menu ● Hold: Enter main menu/Exit main menu and quick menu ● Rotate: Switch digital zoom
	Measure Key + Wheel	<ul style="list-style-type: none"> ● Press: Start or stop recording ● Hold: Correct non-uniformity of display (FFC)

Chapter 2 Preparation

2.1 Cable Connection

Connect the device and power adaptor with a type-C cable to power on the device. Alternatively, connect the device and PC to export files.

Steps

1. Lift the cable interface cover.
2. Connect the device and power adapter with a Type-C cable to power on the device. Alternatively, connect the device and PC to export files.

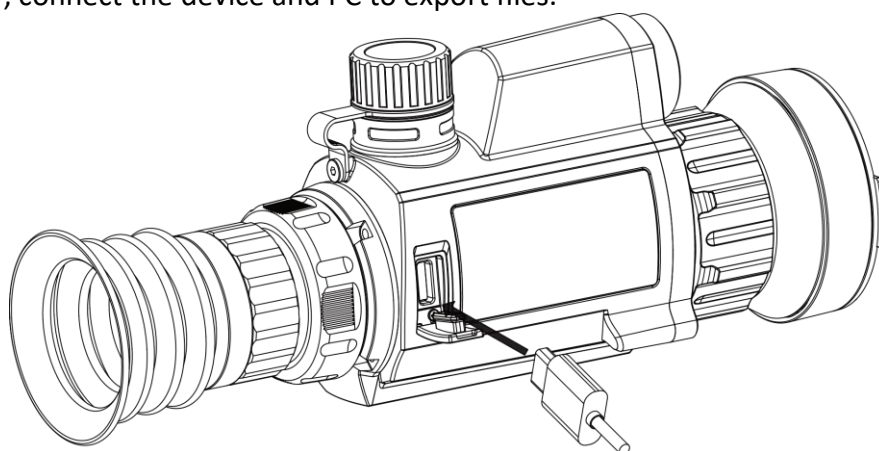

Figure 2-1 Cable Connection

2.2 Install Battery

2.2.1 Battery Instruction

- The battery type is 18650 with the protection board, and the battery size should be 19 mm × 70 mm. The rated voltage is 3.6 VDC, and the battery capacity is 3350 mAh (12.06 Wh).
- Charge the batteries for more than 4 hours before first use.
- Remove the battery if the device is not used for a long time.
- Please purchase the batteries recommended by the manufacturer if necessary.

2.2.2 Battery Installation

Insert the battery into the battery compartment.

Steps

1. Turn the battery cover counterclockwise to loosen it.

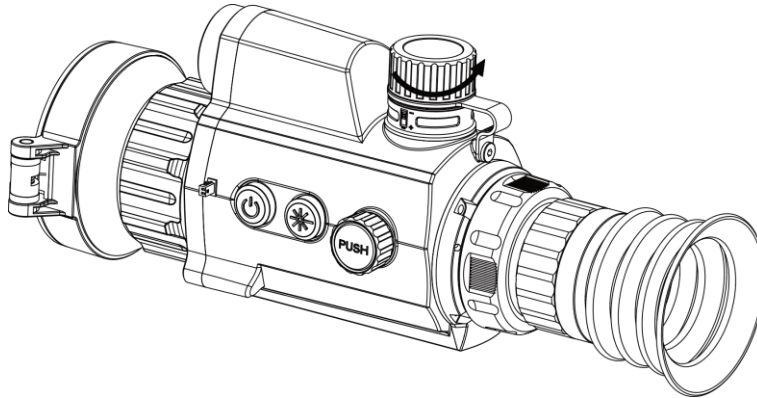

Figure 2-2 Open Battery Cover

2. Insert the battery into the battery compartment with the positive mark inward.

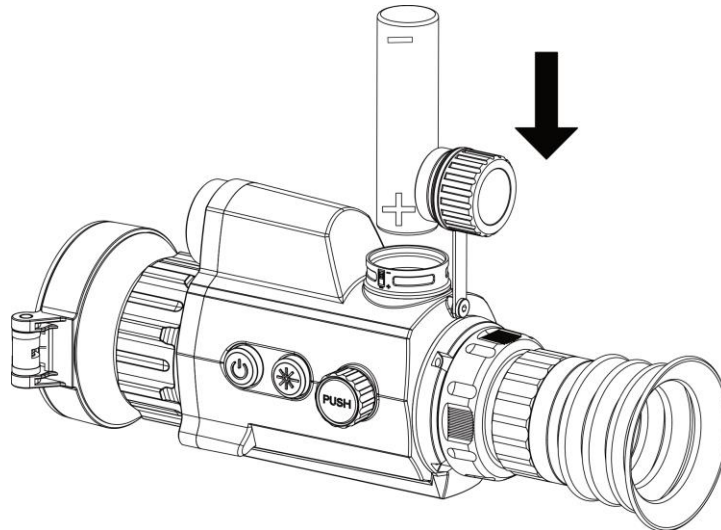

Figure 2-3 Install Battery

3. Turn the battery cover clockwise to tighten it.

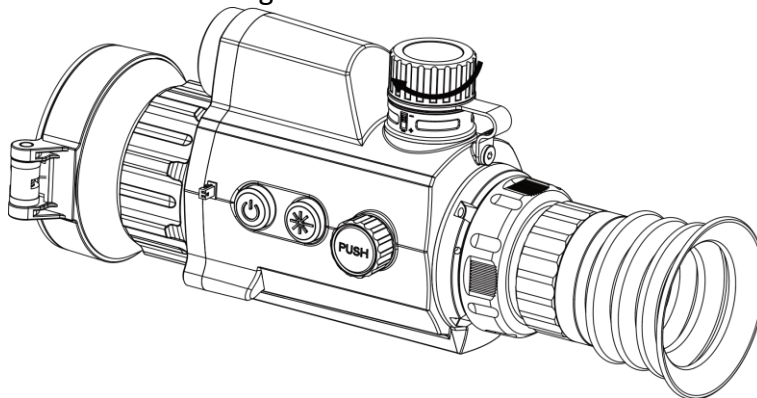

Figure 2-4 Tighten Cover

2.3 Install Rail

Steps

1. Align the screw holes on the device with those on the rail.

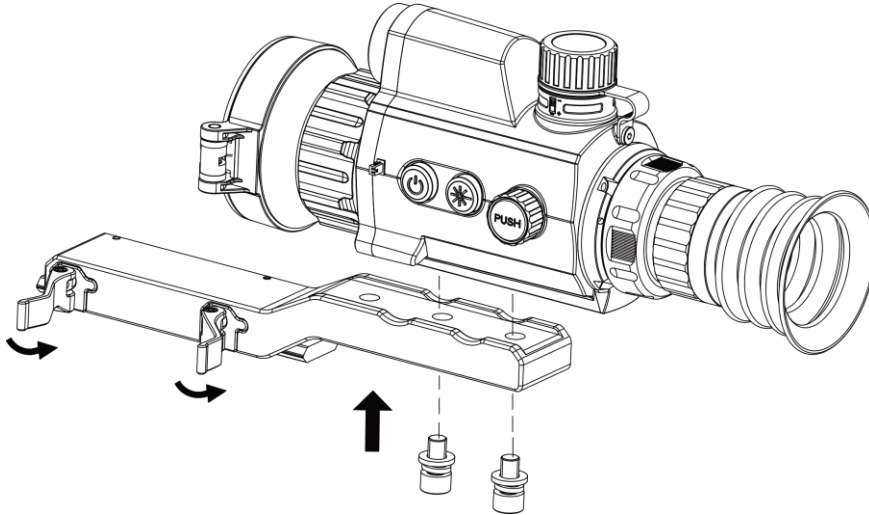

Figure 2-5 Install Screws

2. Insert the screws into the holes and tighten them securely.

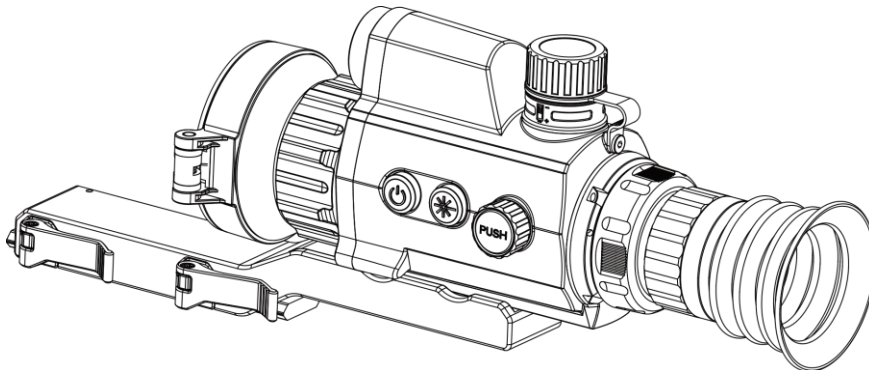

Figure 2-6 Secure Device

3. Tighten the levers to secure the device.



Note

The rail is not included in the package. Please purchase separately it as needed.

2.4 Power On/Off

Power On

When the battery is sufficiently charged, hold  for about 2 seconds to power on the device.

Power Off

When the device is turned on, hold  for 2 seconds to power off the device.



Note

- Power-off countdown will appear when you power off the device. You can press any key to interrupt the countdown and cancel the power-off.
 - Automatic low battery power-off cannot be canceled.
-



Auto Power Off

Set the auto power off time for your device, and then the device will automatically shut down as the set time.

Steps

1. Hold the wheel to go to the menu.
 2. Rotate the wheel to select  **General Settings**, and select .
 3. Rotate and press the wheel to select the auto power off time as required.
 4. Hold the wheel to save and exit.
-

Note

- See the battery icon for the battery status.  means the battery is fully charged, and  means that the battery is low.
 - When the low power note shows, charge the battery.
 - The auto power off countdown will start again when the device exits standby mode, or the device is restarted.
-

2.5 Menu Description

2.5.1 Main Menu

When the device is turned on, hold the wheel to show the menu.

In the menu, you can rotate the wheel to select functions, press the wheel to configure the selected function, and hold the wheel to exit the menu.



Figure 2-7 Main Menu

2.5.2 Quick Menu

In the live view mode, press the wheel to show the quick menu. You can set parameters such as **Mode**, **PIP** (Picture in Picture), **Contrast** and **Brightness** in the quick menu.

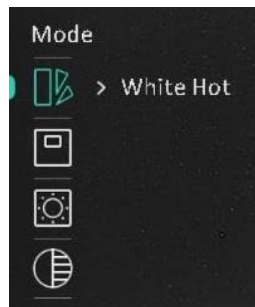

Figure 2-8 Quick Menu

Note

This function varies according to different camera models.

2.6 Client Software Connection

Connect the device to the HIKMICRO Sight app via hotspot, then you can capture picture, record video, or configure parameters on your phone.

Steps

1. Search the HIKMICRO Sight app on App Store (iOS System) or Google Play™ (Android System) to download it, or scan the QR code to download and install the app.



Android System



iOS System

2. Hold the wheel to show the menu of device.
3. Rotate the wheel to select , and press to enable hotspot.
4. Turn on the WLAN of your phone and connect to the hotspot.
 - Hotspot Name: HIKMICRO_Serial No.
 - Hotspot Password: Serial No. (The last 9 numbers of serial No.).
5. Open the app and connect your phone with the device. You can view the interface of device on your phone.

Note

- The device cannot connect to the app if entering wrong password several times. Refer to **Restore Device** to reset the device, and connect the app again.
 - The device should be activated for the first use. The default password must be changed after the activation.
-

2.7 Firmware Status

2.7.1 Check Firmware Status

Steps

1. Open the HIKMICRO Sight and connect your device to the app.
2. Check if there is a red spot on the connection interface. If there is no red spot, the firmware is the latest version. Otherwise, the firmware is not the latest version.

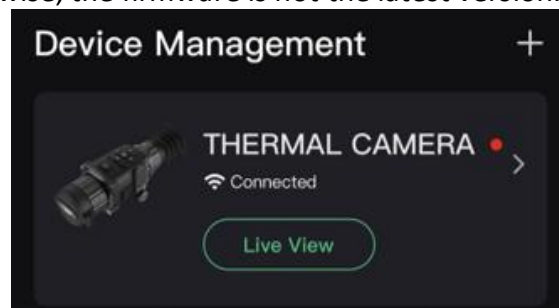

Figure 2-9 Check Firmware Status

3. (Optional) If the firmware is not the latest version, upgrade the device. See **Upgrade Device**.

2.7.2 Upgrade Device

Upgrade Device via HIKMICRO Sight

Before You Start

Install HIKMICRO Sight on your phone and connect your device to the app.

Steps

1. Tap the device series to enter the device information interface.
2. Tap **Device Upgrade** to enter the firmware upgrade interface
3. Tap **Upgrade** to start upgrade.

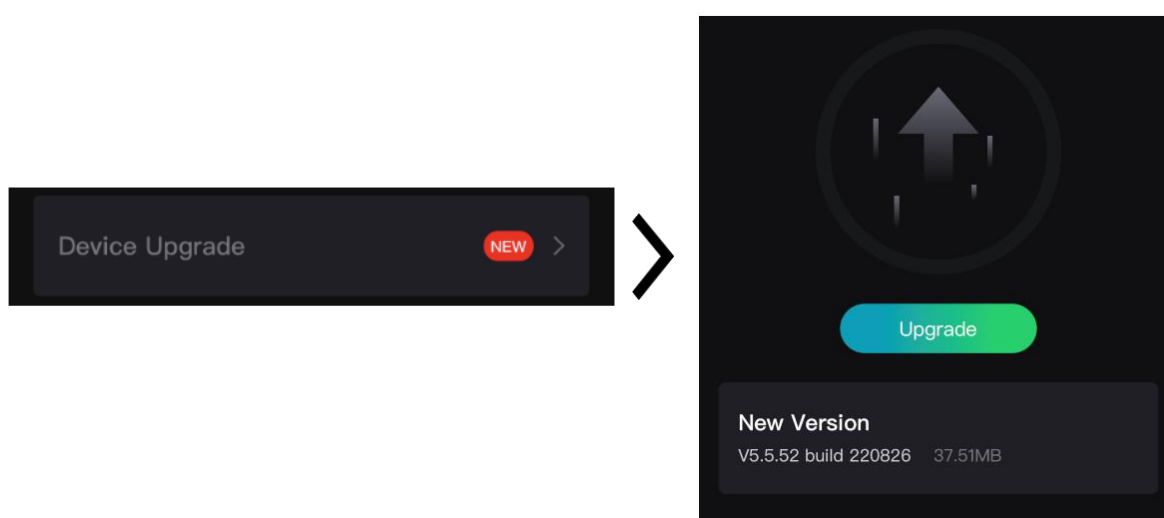

Figure 2-10 Upgrade Firmware

Note

The upgrading operation may vary due to app updates. Please take the actual app version for reference.

Upgrade Device via PC

Before You Start

Please get the upgrade package first.

Steps

1. Connect the device to your PC with cable, and then turn on the device.
2. Open the detected disk, copy the upgrade file and paste it to the root directory of the device.
3. Hold  to reboot the device, and the device upgrades automatically. The upgrading process will be displayed in the main interface.

 **Note**

During the upgrade, make sure the device is connected to your PC. Otherwise, it may cause unnecessary upgrade failure, firmware damage, etc.

2.8 Zeroing

You can enable the reticle to view the position of the target. The functions such as **Freeze** and **Zoom** help to adjust the reticle more accurately. See **Zeroing** for detailed instructions.



Figure 2-11 Zeroing

Chapter 3 Image Settings

3.1 Adjust Diopter

Steps

1. Power on the device.
2. Open the lens cover.
3. Hold the device and make sure the eyepiece covers your eye.
4. Rotate the adjust ring until the OSD text or image is clear.

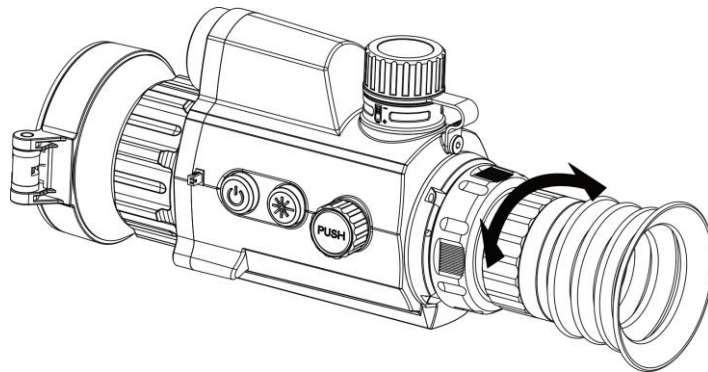

Figure 3-1 Adjust Diopter

Note

When adjusting diopter, DO NOT touch the surface of lens to avoid smearing the lens.

3.2 Adjust Focus

Steps

1. Power on the device.
2. Hold the device and make sure the eyepiece covers your eye.
3. Adjust the focus ring until the image is clear.

Note

When focusing, do not touch the surface of lens to avoid smearing the lens.

3.3 Adjust Brightness

Steps

1. Press the wheel in live view mode to call the quick menu.
2. Rotate and press the wheel to select  .
3. Rotate the wheel to adjust brightness.
4. Hold the wheel to exit and save.

In white hot mode, the higher the value of brightness is, the brighter the image is.

3.4 Adjust Contrast

Steps

1. Press the wheel in live view mode to call the quick menu.
2. Rotate and press the wheel to select  .
3. Press and rotate the wheel to adjust contrast.
4. Hold the wheel to exit and save.

3.5 Adjust Tone

Steps

1. In the main menu, rotate the wheel to select  .
2. Press and rotate the wheel to select a tone. **Warm** and **Cold** are selectable.
3. Hold the wheel to exit and save.

3.6 Adjust Sharpness

Steps

1. In the main menu, rotate the wheel to select  .
2. Press and rotate the wheel to adjust sharpness.
3. Hold the wheel to exit and save.

3.7 Select Scene Mode

You can select proper scene mode according to actual using scene to improve the display effect.

Steps

1. Hold the wheel to go to the menu.
2. Rotate the wheel to select  and press the wheel to switch scene mode.
 - **Recognition**: Recognition mode is recommended in normal scene.
 - **Jungle**: Jungle mode is recommended in hunting environment.
3. Hold the wheel to save settings and exit.

3.8 Set Palettes

You can select different palettes to display the same scene in different effects.

Steps

1. Press the wheel in live view mode to call the quick menu.
2. Rotate the wheel to select .
3. Press and rotate the wheel to select a mode.
4. Hold the wheel to exit and save.

White Hot

The hot part is light-colored in view. The higher the temperature is, the lighter the color is.



Black Hot

The hot part is black-colored in view. The higher the temperature is, the darker the color is.



Red Hot

The hot part is red-colored in view. The higher the temperature is, the redder the color is.



Fusion





From high temperature to low temperature, the image is colored in from white, yellow, red, pink to purple.



3.9 Correct Defective Pixel

The device can correct the defective pixels on the screen which are not performed as expected.

Steps

1. In main menu mode, select  **Function Settings**, and press the wheel to enter the sub-menu.
2. Rotate the wheel to select , and press the wheel to enter the DPC setting interface.
3. Rotate the wheel to select  or  axis and press the wheel to confirm. If you select **X-axis**, the cursor moves left and right; if you select **Y-axis**, the cursor moves up and down.
4. Rotate the wheel to move the cursor until it reaches the defective pixel.
5. Select , and press the wheel to correct the dead pixel.

Note

- The selected defective pixel can be magnified and displayed on the right of the interface.





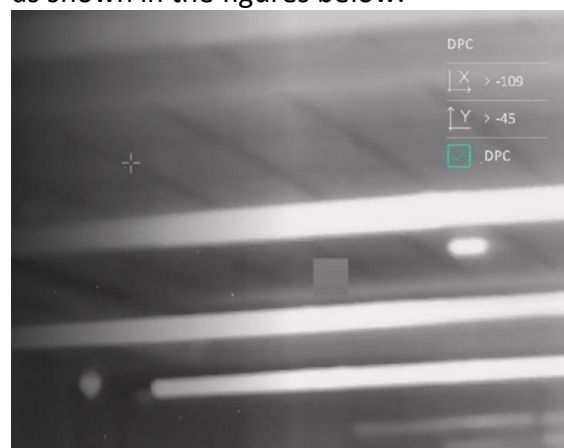

- If the screen OSD blocks the defective pixel, move the cursor to reach the defective pixel, then the device performs mirror display automatically as shown in the figures below.



3.10 Flat Field Correction

This function can correct non-uniformity of display.

Steps

1. In main menu mode, select  **Function Settings** and press the wheel to confirm.
2. Rotate the wheel to select  **Image Calib.**, and press and rotate the wheel to select a FFC mode.
 - Manual FFC: In live view, hold  and the wheel to perform FFC.
 - Auto FFC: The device performs FFC automatically.
 - External: Cover the lens cover, then hold  and the wheel in live view mode to perform FFC.
3. Hold the wheel to save and exit.

Note

- You will hear a click and the image will freeze for a second when the device performs FFC.
 - You can also hold  and the wheel to perform FFC in auto FFC mode.
-

3.11 Set Picture in Picture Mode

Steps

1. Press the wheel in live view to call the quick menu.
2. Rotate the wheel to select .
3. Press the wheel to enable PIP mode. The details show in the upper center.
 - When reticle is enabled, the PIP view is the detail of reticle.
 - When reticle is not enabled, the PIP view is the detail of central part.
3. Hold the wheel to exit.

Note

If digital zoom is enabled, the PIP view also zooms. If the digital zoom ratio exceeds 4, the PIP does not zoom.

3.12 Set Zoom Mode

In the live view mode, you can rotate the wheel to switch the digital zoom of the device.

Steps

1. In the main menu, rotate the wheel to select .
2. Press and rotate the wheel to select a zoom mode.
 - **Continuous:** In the live view mode, rotate the wheel to zoom in or zoom out by 0.1× continuously.
 - **Multiple:** In the live view mode, rotate the wheel to set the digital zoom ratio to 1×, 2×, 4×, or 8×
3. Hold the wheel to save and exit.

Chapter 4 Zeroing

4.1 Select Zeroing Profile

If different users use the same device, the users can configure and save the zeroing settings in their respective zeroing profile.

Steps

1. In the main menu, rotate the wheel to select .
2. Press and rotate the wheel to switch the zeroing profile.
3. Hold the wheel to save and exit.

Result

The right top of the image displays the reticle information. For example, A1-100 m means you are using the No. 1 reticle in zeroing profile A, and the set range is 100 m.

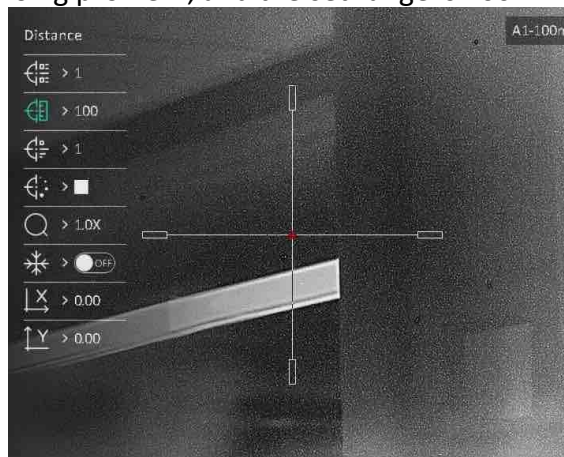

Figure 4-1 Using a Zeroing Profile

Note

There are 5 zeroing profiles in total, and you can configure 5 reticles in each zeroing profile.

4.2 Correct Reticle

Correcting the reticle can help you aim at the target with high accuracy by marking the offset between the big reticle and small reticle. Functions such as **Freeze** and **Zoom** help to adjust the reticle more accurately.

Before You Start

Select a zeroing profile first.

Steps









1. In the main menu, rotate the wheel to select , and press the wheel to enter the setting interface.
2. Select a zeroing No.
 - a) Rotate the wheel to select .
 - b) Press and rotate the wheel to select a zeroing No. to correct.
 - c) Press the wheel again to confirm.
4. Set distance to target.
 - a) Rotate the wheel to select .
 - b) Press the wheel to switch the digit.
 - c) Rotate the wheel to change the number, and press the wheel again to confirm.
5. Aim the target, trigger an activation, and start the zeroing.
 - a) Select , and press and rotate the wheel to enlarge the image until the target positions is clear enough.
 - b) Rotate the wheel to select , press the wheel to freeze the image.
 - c) Select the  or , and press the wheel to confirm. If you select , the reticle moves left and right; if you select , the reticle moves up and down.
 - d) Rotate the wheel to move the big reticle to the required position.
 - e) Hold the wheel to save the settings according to the prompt.



Figure 4-2 Correct Reticle

Note

- When enabling the freeze function in reticle, you can adjust the position of the reticle on a frozen image. This function can prevent image flutter.
 - When you switch the reticle No., a prompt will appear on the interface. Select **OK** to save the parameters for the current reticle.
-



4.3 Set Reticle Style

You can select color and type for your reticle in different environments.

Before You Start

Select a zeroing No.

Steps

1. In the zeroing interface, rotate the wheel to select  or .
 2. Press and rotate the wheel to switch types and colors for your reticle.
 3. Press again to confirm
 4. Hold the wheel to save the settings according to the prompt.
-

Note

In black hot mode and white hot mode, if you set the reticle color as white or black, the colors of reticle will be inverted automatically to better aim at the target.

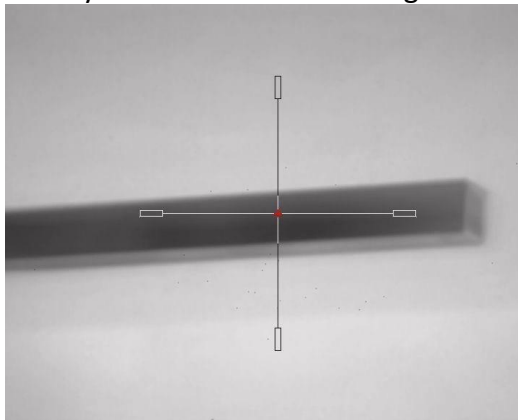



Chapter 5 Measure Distance

The device can detect the distance between the target and the observation position with laser.

Before You Start

When measuring the distance, keep the hand and the position steady. Otherwise, the accuracy may be affected.

Steps

1. In the main menu, rotate the wheel to select .
2. Press and rotate the wheel to select a laser ranging mode.
3. Press the wheel to confirm. **Once** and **Continuous** are selectable.
 - **Continuous:** Measure the distance continuously, and the measurement duration can be selected. The measurement result will be refreshed every 1 s.
 - **Once:** Measure the distance once.
4. Hold the wheel to return to the live view mode.
6. Aim the cursor at the target and press  to measure the target distance.

Note

Press  twice in the live view mode to turn off **Laser Ranging**.

Result

The distance measurement result is displayed at the upper right of the image.





Figure 5-1 Distance Measurement Result

Chapter 6 General Settings

6.1 Set OSD

You can choose whether to display the OSD information on the live view mode in this function.



Steps

1. In main menu, select  **Function Settings** and press the wheel to confirm.
2. Rotate the wheel to select , and press the wheel to enter the setting interface.
3. Rotate the wheel to select **OSD** and press the wheel to enable it.
4. Rotate the wheel to select **Date** or **Time**, and press the wheel to display or hide the information.
5. Hold the wheel to save and exit.

6.2 Set Brand Logo

You can add brand logo on the live view mode.

Steps

1. In main menu, select  **Function Settings** and press the wheel to confirm.
2. Rotate the wheel to select .
3. Press the wheel to enable **Brand Logo**.
4. Hold the wheel to save the settings and exit.



Result

The brand logo is displayed at the bottom left of the image.

6.3 Burning Prevention

This function can prevent the detector of the thermal channel from being burned. When you enable this function, the shield will close if the grey scale of the detector reaches a certain value.

Steps

1. In main menu, select  **Function Settings** and press the wheel to confirm.
2. Rotate the wheel to select , and press the wheel to enable the burn-prevention function.
3. Hold the wheel to save the settings and exit.

 **Note**

Avoid direct sunlight and enable the Burning Prevention function to reduce the risk of sensor damage from the heat.

6.4 Capture and Video

6.4.1 Capture Picture

In the live view mode, hold  to capture picture.

 **Note**

When capturing succeeds, the image freezes for 1 second and a prompt shows on the display. For exporting captured pictures, refer to **Export Files**.

6.4.2 Record Video

Steps



1. In the live view mode, press  and the wheel at the same time to start recording.



Figure 6-1 Start Recording

The left top of image displays the information of recording time.

2. Press  and the wheel at the same time again to stop recording.

What to do next

For exporting recording files, refer to **Export Files**.

6.4.3 Set Audio

If you enable the audio function, the sound will be recorded with the video. When there is too

loud noise in the video, you can disable this function.

Steps

1. In the main menu, rotate the wheel to select .
2. Press the wheel to enable this function.
3. Hold the wheel to save and exit.

6.4.4 Prerecord Video

After enabling this function, the device can automatically record the 7 seconds before and after the recoil-activation.

Steps

1. In the main menu, rotate the wheel to select .
2. Press the wheel to enable this function.
3. Hold the wheel to save and exit.

Note

If you activate recoils continuously, the device will record the 7 seconds before the first recoil until the 7 seconds after the last recoil.

6.5 Hot Tracking

The device can detect the highest temperature spot in the scene and mark it on display.

Steps

1. In the main menu, rotate the wheel to select .
2. Press the wheel enable hot tracking.
3. Hold the wheel to save the settings and exit.

Result



When the function is enabled,  displays in the spot of highest temperature. When the scene changes, the  moves.



Figure 6-2 Hot Tracking

6.6 Export Files

6.6.1 Export Files via HIKMICRO Sight

You can access device albums and export files to your phone via HIKMICRO Sight.

Before You Start

Install HIKMICRO Sight on your mobile phone.

Steps

1. Open HIKMICRO Sight and connect your device to the app. See **2.6 Client Software Connection**.
2. Tap **Media** to access device albums.

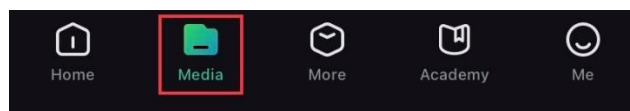

Figure 6-4 Access Device Albums

3. Tap **Local** or **Device** to view the photos and videos.
 - **Local**: You can view the previous files on the app.
 - **Device**: You can view the files of the current device.

Note

The photos or videos may not show in **Device**. Please pull down to refresh the page.

4. Tap to select a file, and tap **Download** to export the file to your local phone albums.



Note

- Go to **Me** → **About** → **User Manual** on the app to see more detailed operations.
- You can also access device albums by tapping bottom left icon in the live view interface.

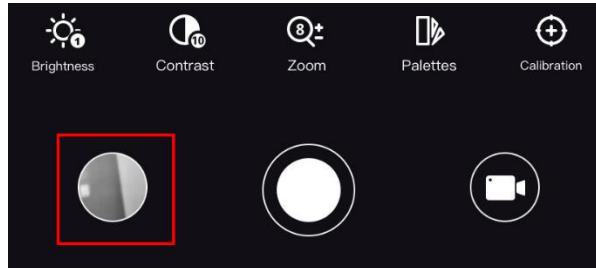

- The exporting operation may vary due to app updates. Please take the actual app version for reference.
-

6.6.2 Export Files via PC

Steps

1. Connect the device and PC with cable.

Note

Make sure the device is turned on when connecting the cable.

2. Open computer disk and select the disk of device. Go to the **DCIM** folder and find the folder named after the capture year and month. For example, if you capture a picture or record a video on June 2021, go to **DCIM** → **202106** to find the picture or video.
 3. Select and copy the files to PC.
 4. Disconnect the device from your PC.
-



Note

- The device displays images when you connect it to PC. But functions such as recording, capturing and hotspot are disabled.
 - When you connect the device to PC for the first time, it installs the drive program automatically.
-

Chapter 7 System Settings

7.1 Adjust Date



Steps

1. In main menu, select  **General Settings** and press the wheel to confirm.
2. Rotate the wheel to select .
3. Press the wheel to select the year, month, or day to be synchronized, and rotate the wheel to change the number.
4. Hold the wheel to save settings and exit.

7.2 Adjust Time

You can select the device language in this function.



Steps

1. In main menu, select  **General Settings** and press the wheel to confirm.
2. Rotate the wheel to select .
3. Press and rotate the wheel to switch the clock system. 24-hour and 12-hour clocks are selectable. In 12-hour clock, press and rotate the wheel to set AM or PM.
4. Press the wheel to select hour or minute, and rotate the wheel to change the number.
5. Hold the wheel to save settings and exit.

7.3 Set Unit

You can switch the unit for laser ranging function.



Steps

1. In main menu, select  **General Settings** and press the wheel to confirm.
2. Rotate the wheel to select .
3. Press and rotate to select a unit. **Yard** and **m** (meter) are selectable.
4. Hold the wheel to save and exit.

7.4 Set Language



You can select the device language in this function.

Steps

1. In main menu, select  **General Settings** and press the wheel to confirm.
2. Rotate the wheel to select .
3. Press and rotate the wheel to select a language. Press again to confirm
4. Hold the wheel to save and exit.



7.5 View Device Information

Steps

1. In main menu, select  **General Settings** and press the wheel to confirm.
2. Rotate the wheel to select .
3. Press the wheel. You can view the device information such as version, and serial No.

7.6 Restore Device

Steps

1. In main menu, select  **General Settings** and press the wheel to confirm.
2. Rotate the wheel to select .
3. Press the wheel to restore the device to defaults according to the prompt.

Chapter 8 Frequently Asked Questions

8.1 Why is the monitor off?

Check whether the device is off-battery. Check the monitor after charging the device for 5 minutes.

8.2 The image is not clear, how to adjust it?

Adjust the diopter adjustment ring until the image is clear. Refer to *Adjust Diopter*.

8.3 Capturing or recording fails. What's the problem?

Check the following items.

- Whether the device is connected to your PC. Capturing or recording is disabled in this status.
- Whether the storage space is full.
- Whether the device is low-battery.

8.4 Why the PC cannot identify the device?

Check the following items.

- Whether the device is connected to your PC with supplied USB cable.
- If you use other USB cables, make sure the cable length is no longer than 1 m.

Safety Instruction



These instructions are intended to ensure that user can use the product correctly to avoid danger or property loss. Please read all the safety information carefully before using.

Laws and Regulations

- Use of the product must be in strict compliance with the local electrical safety regulations.

Symbol Conventions

- The symbols that may be found in this document are defined as follows.

Symbol	Description
 Danger	Indicates a hazardous situation which, if not avoided, will or could result in death or serious injury.
 Caution	Indicates a potentially hazardous situation which, if not avoided, could result in equipment damage, data loss, performance degradation, or unexpected results.
 Note	Provides additional information to emphasize or supplement important points of the main text.

Transportation

- Keep the device in original or similar packaging while transporting it.
- Keep all wrappers after unpacking them for future use. In case of any failure occurred, you need to return the device to the factory with the original wrapper. Transportation without the original wrapper may result in damage on the device and the company shall not take any responsibilities.
- DO NOT drop the product or subject it to physical shock. Keep the device away from magnetic interference.

Power Supply

- Please purchase the adapter by yourself. Input voltage should meet the Limited Power Source (5 VDC, 2A) according to the IEC61010-1 standard. Please refer to technical specifications for detailed information.
- For the device without a supplied power adapter, use the power adapter provided by a qualified manufacturer. Refer to the product specification for detailed power requirements.
- Make sure the plug is properly connected to the power socket.
- DO NOT connect multiple devices to one power adapter, to avoid over-heating or fire hazards caused by overload.
- The battery charger is included in the package. The input voltage for the supplied battery charger should meet the Limited Power Source (5 VDC, 2 A).
- The power source should meet limited power source or PS2 requirements according to IEC

60950-1 OR IEC 62368-1 standard.

Battery

- Improper use or replacement of the battery may result in explosion hazard. Replace with the same or equivalent type only.
- The battery type is 18650 with the protection board, and the battery size should be 19 mm × 70 mm. The rated voltage and capacity are 3.6 VDC/3350 mAh (12.06 Wh). Dispose of used batteries in conformance with the instructions provided by the battery manufacturer.
- Make sure the battery temperature is between 0 °C to 45 °C (32 °F to 113 °F) when charging.
- For long-term storage of the battery, make sure it is fully charged every half year to ensure the battery quality. Otherwise, damage may occur.
- For the device without a supplied battery, use the battery provided by a qualified manufacturer. Refer to the product specification for detailed battery requirements.
- Do not charge other battery types with the supplied charger. Confirm there is no flammable material within 2 m of the charger during charging.
- DO NOT place the battery near heating or fire source. Avoid direct sunlight.
- DO NOT swallow the battery to avoid chemical burns.
- DO NOT place the battery in the reach of children.
- The battery cannot be charged with external power source directly.
- The device cannot be charged, please use the supplied charger to charge the battery.
- Please purchase the adapter by yourself. The using environment of the adapter should be consistent with that of the device.

Maintenance

- If the product does not work properly, please contact your dealer or the nearest service center. We shall not assume any responsibility for problems caused by unauthorized repair or maintenance.
- Wipe the device gently with a clean cloth and a small quantity of ethanol, if necessary.
- If the equipment is used in a manner not specified by the manufacturer, the protection provided by the device may be impaired.
- Clean the lens with soft and dry cloth or wiping paper to avoid scratching it.
- It is recommended to reboot the device every 2 hours when using it to ensure the device performance.

Using Environment

- Make sure the running environment meets the requirement of the device. The operating temperature shall be -30°C to 55°C (-22°F to 131°F), and the operating humidity shall be 95% or less.
- DO NOT expose the device to extremely hot, cold, dusty, corrosive, saline-alkali, or damp environments.
- Avoid equipment installation on vibratory surface or places subject to shock (neglect may cause equipment damage).
- DO NOT aim the lens at the sun or any other bright light.

Emergency

- If smoke, odor, or noise arises from the device, immediately turn off the power, unplug the power cable, and contact the service center.

Laser



When any laser equipment is in use, make sure that the device lens is not exposed to the laser beam, or it may burn out. The laser radiation emitted from the device can cause eye injuries, burning of skin or inflammable substances. Before enabling the light supplement function, make sure no human or inflammable substances are in front of the laser lens. Do not place the device where minors can fetch it.

Manufacture Address

Room 313, Unit B, Building 2, 399 Danfeng Road, Xixing Subdistrict, Binjiang District, Hangzhou, Zhejiang 310052, China
Hangzhou Microimage Software Co., Ltd.

COMPLIANCE NOTICE: The thermal series products might be subject to export controls in various countries or regions, including without limitation, the United States, European Union, United Kingdom and/or other member countries of the Wassenaar Arrangement. Please consult your professional legal or compliance expert or local government authorities for any necessary export license requirements if you intend to transfer, export, re-export the thermal series products among different countries.

Legal Information

Read all information and instructions in this document carefully before using the device and keep it for further reference.

For more device information and instructions, please visit our website at <https://www.hikmicro.com>.

You can also refer to other documents (if any) accompanying the device or scan the QR code (if any) on the packaging to get more information.

©2023 Hangzhou Microimage Software Co., Ltd. All rights reserved.

About this Manual

The Manual includes instructions for using and managing the Product. Pictures, charts, images and all other information hereinafter are for description and explanation only. The information contained in the Manual is subject to change, without notice, due to firmware updates or other reasons. Please find the latest version of this Manual at the HIKMICRO website (<http://www.hikmicrotech.com>).

Please use this Manual with the guidance and assistance of professionals trained in supporting the Product.

Trademarks



HIKMICRO and other HIKMICRO's trademarks and logos are the properties of HIKMICRO in various jurisdictions.

Other trademarks and logos mentioned are the properties of their respective owners.

Disclaimer

TO THE MAXIMUM EXTENT PERMITTED BY APPLICABLE LAW, THIS MANUAL AND THE PRODUCT DESCRIBED, WITH ITS HARDWARE, SOFTWARE AND FIRMWARE, ARE PROVIDED "AS IS" AND "WITH ALL FAULTS AND ERRORS". HIKMICRO MAKES NO WARRANTIES, EXPRESS OR IMPLIED, INCLUDING WITHOUT LIMITATION, MERCHANTABILITY, SATISFACTORY QUALITY, OR FITNESS FOR A PARTICULAR PURPOSE. THE USE OF THE PRODUCT BY YOU IS AT YOUR OWN RISK. IN NO EVENT WILL HIKMICRO BE LIABLE TO YOU FOR ANY SPECIAL, CONSEQUENTIAL, INCIDENTAL, OR INDIRECT DAMAGES, INCLUDING, AMONG OTHERS, DAMAGES FOR LOSS OF BUSINESS PROFITS, BUSINESS INTERRUPTION, OR LOSS OF DATA, CORRUPTION OF SYSTEMS, OR LOSS OF DOCUMENTATION, WHETHER BASED ON BREACH OF CONTRACT, TORT (INCLUDING NEGLIGENCE), PRODUCT LIABILITY, OR OTHERWISE, IN CONNECTION WITH THE USE OF THE PRODUCT, EVEN IF HIKMICRO HAS BEEN ADVISED OF THE POSSIBILITY OF SUCH DAMAGES OR LOSS.

YOU ACKNOWLEDGE THAT THE NATURE OF THE INTERNET PROVIDES FOR INHERENT SECURITY RISKS, AND HIKMICRO SHALL NOT TAKE ANY RESPONSIBILITIES FOR ABNORMAL OPERATION, PRIVACY LEAKAGE OR OTHER DAMAGES RESULTING FROM CYBER-ATTACK, HACKER ATTACK, VIRUS INFECTION, OR OTHER INTERNET SECURITY RISKS; HOWEVER, HIKMICRO WILL PROVIDE TIMELY TECHNICAL SUPPORT IF REQUIRED.

YOU AGREE TO USE THIS PRODUCT IN COMPLIANCE WITH ALL APPLICABLE LAWS, AND YOU ARE SOLELY RESPONSIBLE FOR ENSURING THAT YOUR USE CONFORMS TO THE APPLICABLE LAW. ESPECIALLY, YOU ARE RESPONSIBLE, FOR USING THIS PRODUCT IN A MANNER THAT DOES NOT INFRINGE ON THE RIGHTS OF THIRD PARTIES, INCLUDING WITHOUT LIMITATION, RIGHTS OF PUBLICITY, INTELLECTUAL PROPERTY RIGHTS, OR DATA PROTECTION AND OTHER PRIVACY RIGHTS. YOU SHALL NOT USE THIS PRODUCT FOR ILLEGAL HUNTING ANIMALS, INVASION OF PRIVACY OR ANY OTHER PURPOSE WHICH IS ILLEGAL OR DETRIMENTAL TO THE PUBLIC INTEREST. YOU SHALL NOT USE THIS PRODUCT FOR ANY PROHIBITED END-USES, INCLUDING THE DEVELOPMENT OR PRODUCTION OF WEAPONS OF MASS DESTRUCTION, THE DEVELOPMENT OR PRODUCTION OF CHEMICAL OR BIOLOGICAL WEAPONS, ANY ACTIVITIES IN THE CONTEXT RELATED TO ANY NUCLEAR EXPLOSIVE OR UNSAFE NUCLEAR FUEL-CYCLE, OR IN SUPPORT OF HUMAN RIGHTS ABUSES.

PLEASE FOLLOW ALL THE PROHIBITIONS AND EXCEPTIONAL CAVEATS OF ALL APPLICABLE LAWS AND REGULATIONS, IN PARTICULAR, THE LOCAL FIREARMS AND/OR HUNTING LAWS AND REGULATIONS. PLEASE ALWAYS CHECK NATIONAL PROVISIONS AND REGULATIONS BEFORE PURCHASE OR USE OF THIS PRODUCT. PLEASE NOTE THAT YOU MAY HAVE TO APPLY FOR PERMITS, CERTIFICATES, AND/OR LICENSES BEFORE ANY PURCHASING, SELLING, MARKETING AND/OR USING OF THE PRODUCT. HIKMICRO SHALL NOT BE LIABLE FOR ANY SUCH ILLEGAL OR IMPROPER PURCHASING, SELLING, MARKETING, AND END USES AND ANY SPECIAL, CONSEQUENTIAL, INCIDENTAL, OR INDIRECT DAMAGES ARISING THEREOF. IN THE EVENT OF ANY CONFLICTS BETWEEN THIS MANUAL AND THE APPLICABLE LAW, THE LATTER PREVAILS.

Regulatory Information

These clauses apply only to the products bearing the corresponding mark or information.

EU/UK Conformity Statement



This product and - if applicable - the supplied accessories too are marked with "CE" and comply therefore with the applicable harmonized European standards listed under the Directive 2014/30/EU (EMCD), Directive 2014/35/EU (LVD), Directive 2011/65/EU (RoHS), Directive 2014/53/EU.



This product and - if applicable - the supplied accessories too are marked with "UKCA" and comply therefore with the following directives: Radio Equipment Regulations 2017, Electromagnetic Compatibility Regulations 2016, Electrical Equipment (Safety) Regulations 2016, the Restriction of the Use of Certain Hazardous Substances in Electrical and Electronic Equipment Regulations 2012.

Frequency Bands and Power (for CE/UKCA)

The frequency bands and transmitting power (radiated and/or conducted) nominal limits applicable to the following radio equipment are as follows:

Wi-Fi 2.4 GHz (2.4 GHz to 2.4835 GHz), 20 dBm.



Directive 2012/19/EU (WEEE Directive): Products marked with this symbol cannot be disposed of as unsorted municipal waste in the European Union. For proper recycling, return this product to your local supplier upon the purchase of equivalent new equipment, or dispose of it at designated collection points. For more information see: www.recyclethis.info.

According to the Waste Electrical and Electronic Equipment Regulations 2013: Products marked with this symbol cannot be disposed of as unsorted municipal waste in the United Kingdom. For proper recycling, return this product to your local supplier upon the purchase of equivalent new equipment, or dispose of it at designated collection points. For more information see: www.recyclethis.info.



Directive 2012/19/EU (WEEE Directive): Products marked with this symbol cannot be disposed of as unsorted municipal waste in the European Union. For proper recycling, return this product to your local supplier upon the purchase of equivalent new equipment, or dispose of it at designated collection points. For more information see: www.recyclethis.info.

According to the Waste Electrical and Electronic Equipment Regulations 2013: Products marked with this symbol cannot be disposed of as unsorted municipal waste in the United Kingdom. For proper recycling, return this product to your

local supplier upon the purchase of equivalent new equipment, or dispose of it at designated collection points. For more information see: www.recyclethis.info.

Use the power adapter provided by a qualified manufacturer. Refer to the product specification for detailed power requirements.

Use the battery provided by a qualified manufacturer. Refer to the product specification for detailed battery requirements.



HIKMICRO

See the World in a New Way



Facebook: HIKMICRO Outdoor Instagram: hikmicro_outdoor

YouTube: HIKMICRO Outdoor

LinkedIn: HIKMICRO

Website: www.hikmicrotech.com

E-mail: support@hikmicrotech.com

UD32895B